



SOCIAL+CONSTRUCTED
SOLIDARITY

PATRYCJA SAKOWSKA
MASTER'S OF ARCHITECTURE THESIS

UNIVERSITY OF DETROIT MERCY | SCHOOL OF ARCHITECTURE
ARCH. 5100, 5110, 5200, 5210
KAREN SWANSON, ADVISOR
APRIL 2012

PATRYCJA SAKOWSKA
MASTER'S OF ARCHITECTURE
THESIS

UNIVERSITY OF DETROIT MERCY |
SCHOOL OF ARCHITECTURE
ARCH. 5100, 5110, 5200, 5210
KAREN SWANSON, ADVISOR
APRIL 2012

PATRYCJA SAKOWSKA
ARCHITECTURE

ABSTRACT
THESIS PAPER

ARCHITECTURAL PRECEDENTS
ORGANIZATIONAL PRECEDENTS

REGIONAL ANALYSIS
SITE ANALYSIS

SCHEMATIC DESIGN
FINAL DESIGN

1980
1981

Solidarność



SOLIDARNOSCI FOR POLSKA

ABSTRACT | 002 |

A tool for empowerment and progress is design. As the world continues to grow and shift, socially, culturally, economically, and politically, physical space continues to shift, and the need for the architects expertise and creative (re) solutions is needed.

The architect must act as the social entrepreneur. must design in response to the local and cultural aspirations of the community whilst promoting the efficient use of resources.

Poland is a country with a loaded history of destruction, war, rebirth and renewal politically, economically, culturally and socially. Even after the devastating effects of World War II, it is the most successful “transition” economy in the European Union.

Though many urban areas of Poland are developing themselves, the small farm which makes up most of Poland’s topography is stagnant and in need of change and “transition”. The rural- urban edge connection is diminishing and needs to be repurposed. A need for a community based rural-urban connection is needed. In Poland today, there are still 2 million farms, many of which who are struggling and in competition with corporate farms in Western Europe.

This thesis seeks to answer and develop a solution for the small farm.

MANY GENERATIONS TO COME WILL REMEMBER

THE EXTRAORDINARY THING

THAT HAPPENED IN POLAND

THERE APPEARED A SOCIAL FORCE

ABLE TO CONTROL THOSE IN POWER.



MANY GENERATIONS TO COME WILL REMEMBER

THE EXTRAORDINARY THING

THAT HAPPENED IN POLAND

THERE APPEARED A SOCIAL FORCE

ABLE TO CONTROL THOSE IN POWER.

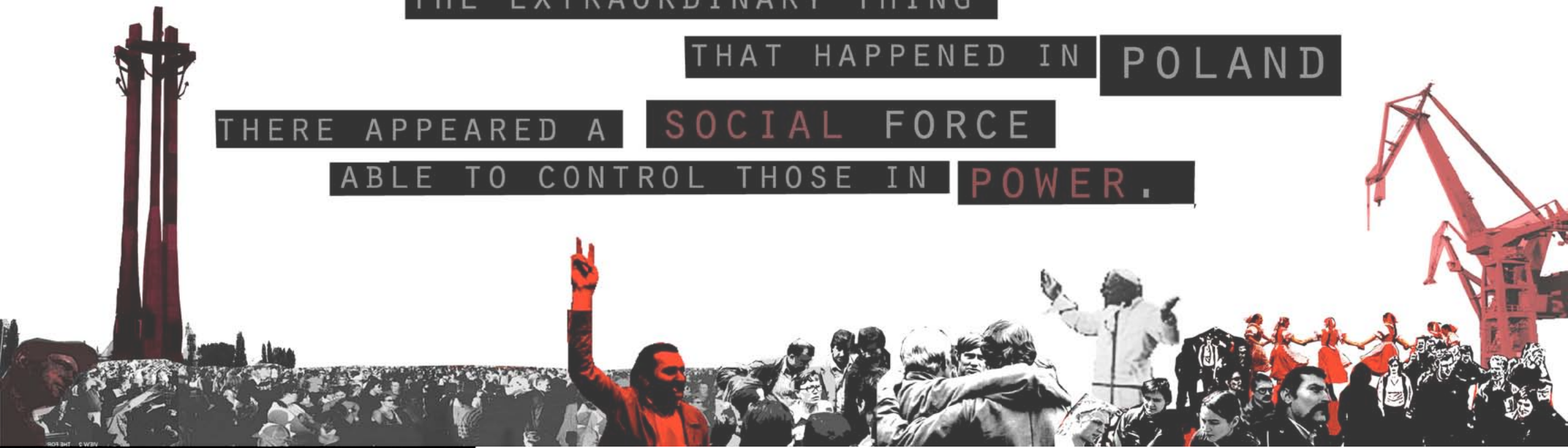

MANY GENERATIONS TO COME WILL REMEMBER

THE EXTRAORDINARY THING

THAT HAPPENED IN POLAND

THERE APPEARED A SOCIAL FORCE

ABLE TO CONTROL THOSE IN POWER.

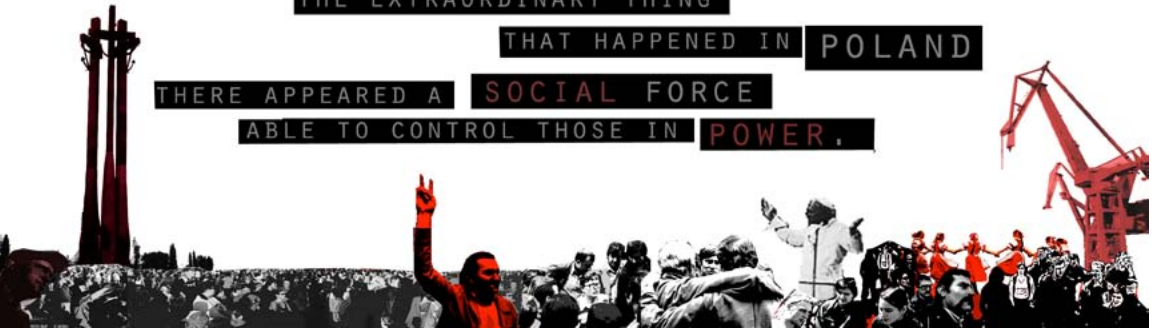

A tool for empowerment and progress is design. As the world continues to grow and shift, socially, culturally, economically, and politically, physical space continues to shift, and the need for the architects expertise and creative (re) solutions is needed.

Poland is a country with a loaded history of destruction, war, rebirth and renewal politically, economically, culturally and socially. Even after the devastating effects of World War II, it is the most successful “transition” economy in the European Union. Transitioning from Communist control to the market economy affected the whole of Polish society. Though many urban areas of Poland are re-developing themselves and growing, the small farm which makes up most of Poland’s topography needs redevelopment. 1

BRYAN BELL

Good design has the potential to serve everyone- more people than it currently does. Design and architecture place a direct role in addressing critical social issues that we face today. The process of creating the built environment can allow communities and individuals to improve and celebrate their lives. It can help solve their struggles by reshaping their existence.

If we wish to achieve a sustainable future for humanity, the architect must design in response to the local and cultural aspirations of the community whilst promoting the efficient use of resources.

During the transition unequal distribution of economic benefits among various working groups deepened social differences. Long-term negligence of certain social issues, inadequate housing, unemployment, and lack of continuous education continues to affect vulnerable groups to this day. The physical landscape, and the rural-urban connection has been overlooked. The small farmer has been left to compete with mass producing food systems.

The Solidarity Movement that began in the 1980's ignited one of the most important social movements in Poland's history. For the people of Poland brought down repressive Communist dictatorship. The movement reinvigorated citizenship through participation and national motivation, which sparked the domino like effect of empowerment throughout the rest of Eastern Europe.

Each movement reflects the political, economic, and cultural issues of the time. representing a different amalgamation of good deeds and good design, and profoundly influencing the practice and education of architecture

The architectural profession reflects a dichotomy similar to the practices of physicians and lawyers, in that professionals work mainly with clients, elitist individuals, corporations, institutions, and governments—who can afford to pay professional fees and who receive, in exchange, highly customized responses to their specific needs. This form of practice has led to the design and construction of many visually powerful and functionally successful buildings, but it has limited the number and types of people served by the profession.

The concept of “Solidarnosc” and its importance in design and society must be re-thought.

“[There was] tremendous hope and a kind of electricity between people. You know, it's said that we Poles become a nation once a generation, just like we did recently when the pope died, and that was one of those moments when, suddenly, millions of people felt that they wanted the same thing, which was free trade unions to represent them against the [Communist] Party. It gave people hope that perhaps communism could be reformed. We now know that it couldn't.” 2



COMMUNITY

ENGAGEMENT

COLLABORATION

KNOWLEDGE

REVOLUTION

The conditions allow for new generation of creative design to be carried out in the service of the greater public and greater good by good. Architecture is powerful. Architecture is political. Architecture is activism. The time is right for an architecture that does good by being good.

FRANK GEHRY
Just being an architect is an act of social responsibility. Even the strangest concoctions of our imaginations have to do with humanist values-with people, society and context. We're all part of the human fabric.

The social conditions in Poland and in the United States no where near come close to the extremes of wealth and impoverishment or the depths of desperation experienced by billions of people elsewhere in the world, the current social issues amongst groups should not be overlooked. With the global population anticipated to increase to about 9 billion by 2050, the United Nations expects the number of people living in slums to reach 2 billion by the same date.

LEONIE SANDER
Architecture has the ability to transform the user. It is the individuals duty as a city to participate and influence the physical space in which they occupy. The forces that influences the ideas, knowledge bases, and practices of our discipline are in constant flux. What is needed is an architecture of change—an architecture that moves beyond the design of buildings and toward the design of new processes of engagement with the political forces that shape theories, practices, academies, policies, and communities. we can no longer deny the undeniable space and its making are political. The architects political engagement is to develop tiny empowerments and a systematic change.

Solidarity in its most prime definition is the feelings of togetherness and common interest of social bonds and integration, in the early nineteenth century was believed to be diminishing due to the birth of modernism that created the tear in the process of solidarity. As a political concept solidarity is the individuals civil interaction Solidarity economy seeks to “humanize” the capitalist economy- to supplementing the capitalist globalization with community-based social safety nets. Cultural solidarity is the specific cultural bonds of a particular group that form a collective whole.

Emilie Durkheim put for the theory of solidarity Mechanical solidarity takes place in primitive and traditional societies, societies in which bonding or interdependency rests on a similarity of beliefs and values, shared activities, and ties of kinship and cooperation. Its cohesion and integration comes from the homogeneity of individuals. People feel connected through similar work, educational and religious training, and lifestyle. Durkheim conceives solidarity in a relational mode- form of sociability that designates the relationship of the structure and functioning of society

The phenomenon of solidarity allows for an internal sense of experience- transforming the personal conscience while influencing the collective conscience.

DURKHEIM



Society does not consist of individuals; it expresses the sum of connections and relationships in which individuals find themselves.' Humanity relates to the physical world through labour; through labour humanity itself develops and labour is the source of human beings' relationships with each other. What happens to the process of work, therefore, has a decisive influence on the whole of society. By thus acting on the external world and changing it, he at the same time changes his own nature. Thus labour is a dynamic process through which the labourer shapes and moulds the world he lives in and stimulates himself to create and innovate.

KANT



If the relevance of architecture can be transformed through a critical engagement with the practices that shape the production of space, then the culture of architectural education (followed by practice) can also be transformed to create an economically and culturally diverse set of actors and audiences that perceive the profession as an active participant in the transformation of society.

The foundation of architectural thought is constantly shifting. Theories are offered, accepted, disproved, and abandoned in rapid succession. Each movement reflects the political, economic, and cultural issues of the time, representing a different amalgamation of good deeds and good design, and profoundly influencing the practice and education of architecture. If we do not act now to begin a spatialized political effort and to implement an architecture of change, the polarization emerging around the globe will continue; the twenty first century will be defined by a paradigm of access to space through division; and the tools for transforming space will become increasingly concentrated in the hands of the few.

GAMEZ + ROGERS

The architect traditionally was the master builder graphically presenting the design concept + structure + materials, and overseer of construction. The role has changed, the architect now plays within networks, the advancement + change in society + cultural diversity. We must challenge and embrace this trajectory and design with solidarity. Architects must support and design with the community and their aspirations, raising awareness of the physical environment to establish a design influenced by all.

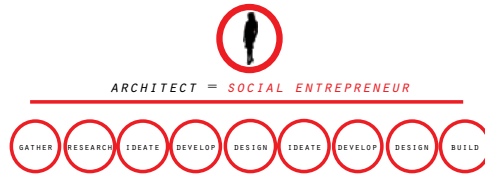

Architecture and all of the design professions re undergoing a major transformation that is both proactive and reactive: proactive as a search for roles with greater relevance, an a reactive as a response to the humanitarian and environmental crises facing the world.

THOMAS FISHER

The return of the political to architecture does not involve designing a building but designing a process of political engagement—one by which architectural ideas, strategies, practices, and values are developed and disseminated in collaboration and contestation with greater society.

The architectural profession reflects a dichotomy similar to the practices of physicians and lawyers, in that professionals work mainly with clients—wealthy individuals, corporations, institutions, and governments—who can afford to pay professional fees and who receive, in exchange, highly customized responses to their specific needs. This form of practice has led to the design and construction of many visually powerful and functionally successful buildings, but it has limited the number and types of people served by the profession.



A methodology put forth in the United States, “New Ruralism” is a framework created to bridge Sustainable Agriculture and New Urbanism. Realising the disconnect between the urban and rural edge, new ruralism embraces the symbiotic relationship between these areas.

New Ruralism is the preservation and enhancement of urban edge rural areas as places that are indispensable to the economic, environmental, and cultural vitality of cities and metropolitan regions.

New ruralism must work in hand with this vision and with the unique identity rooted in the agricultural, ecological, geographical and cultural attributes of the specific place. The identity would contribute to a broader regional sense of place, through local farm products, rural activities, iconic landscape, and opportunities for public experience. Urban-rural connectivity would be a multi-faceted exchange.



I Bibliography I

Ahmed, S. (2004). The cultural politics of emotion. New York, NY: The Cromwell Press.

Arnsperger, C., & Varoufakis, Y. (2003). Toward a theory of solidarity. *Erkenntnis*, 59(2), 157-188.

Burning man. (n.d.). Retrieved from <http://www.burningman.com/>

Donovan, J. (2005, August 24). Poland: Solidarity -- the trade union that changed the world. Retrieved from <http://www.rferl.org/content/article/1060898.html>

Durkheim, E. (1984). The division of labour in society. (First ed.). New York : The Free Press.

Durkheim, E. (1966). The rules of the sociological method. New York : The Free Press.

Elshahed, M. (2011, February 27). Tahrir square: Social media, public space. Retrieved from <http://places.designobserver.com/feature/tahrir-square-social-media-public-space/25108/>

Goldbard, A. (2010). New creative community. (3rd ed.). Oakland, Ca: New Village Press

Kenneth Allan; Kenneth D. Allan (2 November 2005). Explorations in Classical Sociological Theory: Seeing the Social World. Pine Forge Press.

Ling, R. (2008). New tech, new ties. Cambridge, Massachusetts: The MIT Press.

Marmot , A. (1983). Urbanism in warsaw: Solidarity and beyond. *Places*, 1(2).

Mawson, A. (2008). The social entrepreneur. London, England: MPG Books, Ltd.

Perego, A., Conanno, A., Passamani, M., & Porcu, P. (2011, March 11). Revolutionary solidarity. Retrieved from http://theanarchistlibrary.org/pdfs/a4_imposed/Various_Authors___Revolutionary_Solidarity_a4_imposed.pdf

Rippe, K. P. (1998). Diminishing solidarity. *Ethical Theory and Moral Practice*, 1(3), 355-374.

Zeiger, M. (2011). The new design activism. *Azure Magazine*

Burkina faso development, africa : Informa images. (n.d.). Retrieved from http://www.e-architect.co.uk/africa/centre_pour_le_bien_etre_des_femmes.htm

Bldg blog-mathscape. (n.d.). Retrieved from <http://bldgblog.blogspot.com/2009/02/mathscape.html>

S(ch)austall. (n.d.). Retrieved from <http://archipelagoes.blogspot.com/2008/04/schaustall-fnp-architekten.html>



ARCHITECTURAL PRECEDENT | 023 |

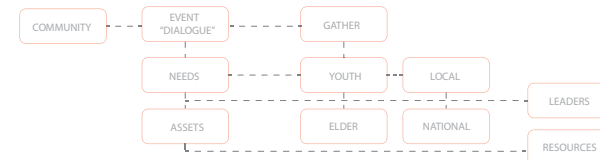

The Center for the Welfare of Women in Burkina Faso is located in one of the poorest areas of Ouagadougou. The center designed by FARE Studio from Rome was designed as a prototype that can be replicated throughout the region. The project's mission was to improve the human spirit and address the humanitarian crisis of genital mutilation.

The social program called for a building complex capable of hosting a variety of activities in very harsh circumstances. The architectural project represents the response to this condition. The health center provides educational services, information and awareness about women's sexual and reproductive rights.

The design and needs for the users of the building were addressed through dialogue with the community. The men of the community and local builder used an innovative approach to traditional local building practices. A critical function for the building was to shade and ventilate the building, thereby reducing the use of air conditioning. The building is raised off the ground and shaded by a PVC canopy. The building sources water from its own well and energy from photovoltaic cells.

Although the center is directed towards the education of women, the exterior space, similar to the interior, is designed as an open area to be used by the entire community. It is a space of sharing and of information, used to present the themes dealt with by the CBF. Indirect and informal communication is also favored by the organization of small events and public discussions. The garden is a micro environment that surrounds the buildings taking advantage of the shade provided by the building and trees and the humidity produced by the plants.



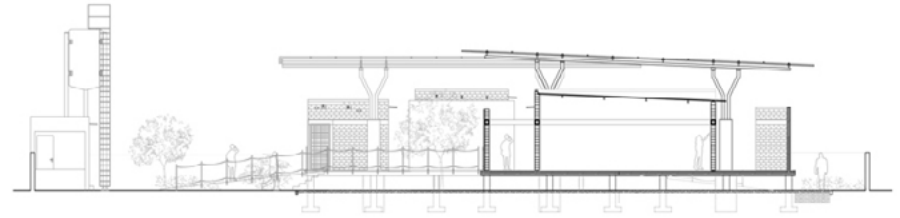
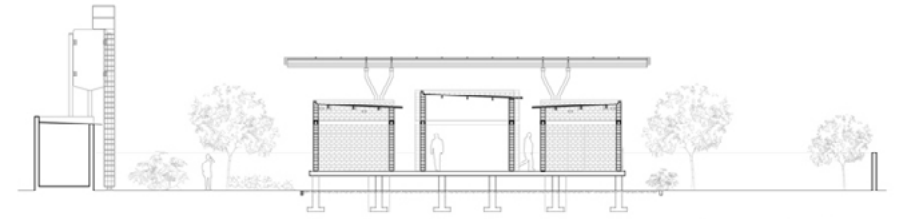

COMMUNITY

ENGAGEMENT

COLLABORATION

KNOWLEDGE

REVOLUTION

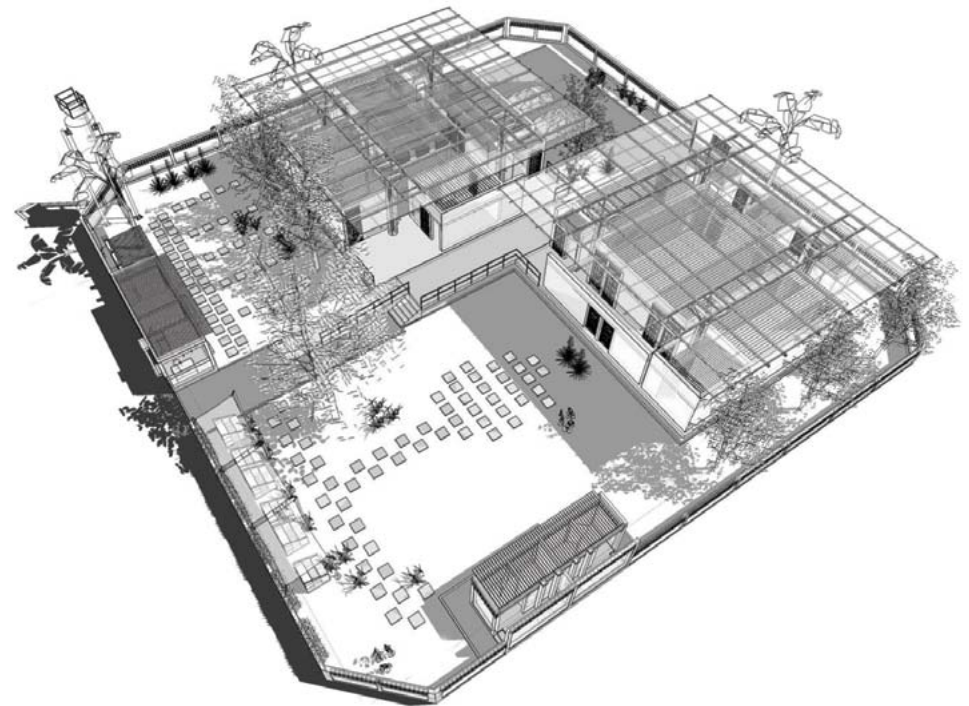

PROJECT H

Project H Design is a humanitarian non-profit organization using hands-on building to catalyze communities and public education within. The core values of the organization are “Humanity, Habitats, Health, Happiness, Heart and Hands”.

The current project of Project H is a public high school “design/build” program based in rural Bertie County, NC that works towards community development through design. The studio allows the students to critically think about their environments and their role as citizens and designers, to provide creative and active solutions to their community.

The students are able to earn high-school credits and transferable college credits for partaking in the course. Students are offered part-time construction jobs to build the community project they designed and prototyped.





CITIZENS ENJOYING THEIR CHICKEN COUP DESIGNED AND BUILT BY THE STUDENTS.



MATHSCAPE

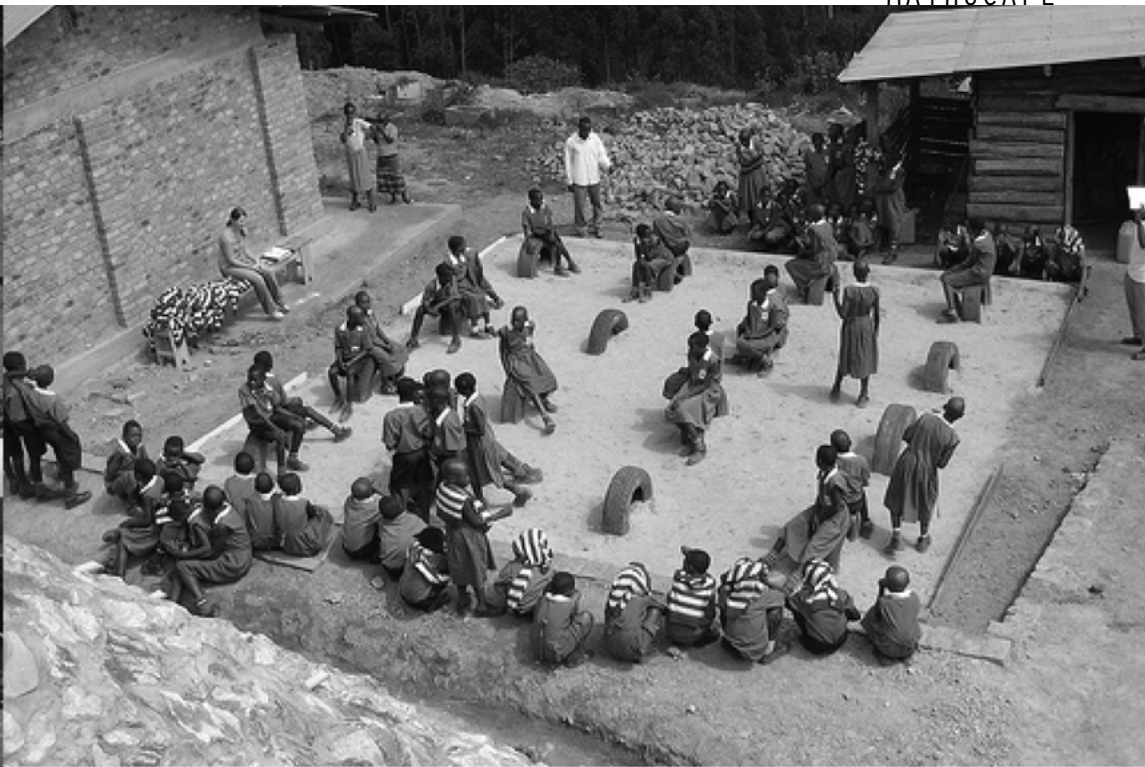

TAHRIR SQUARE

Tahrir Square (Liberation Square) is a major public square located in downtown Cairo. The Square when first commissioned was a lively epicenter in the city, and a place of demonstration. Major protests that took place at the square were the 1977 Egyptian Bread Riots and in 2003, protest against the war in Iraq. Under the control of Mubarek the square was fenced off, part of the governmental policy discouraging public assembly. In 2011, the square was taken over by the citizens of Egypt who protested against Mubarek and eventually overthrew the corrupt ruler. The importance of social space in solidarity is that Social space creates a place of ownership where an individual and community can express and create Cultural Revolution. The urban space acts the stage for solidarity in place.



ARCHITECTURAL PRECEDENT | 034 |



TODAY

Stuttgart firm FNP Architekten re-converted an old shed in the Rhineland of Germany, calling this old pig shed, now a showroom. The strategy used in the development was creating a frame identical to the pig shed, “A house within a house”. The older structure from the 18th century, was respected and enhanced with the natural interior.

The new design strategy delicately inserts a new intervention respecting the historical artifact.

ARCHITECTURAL PRECEDENT | 036 |

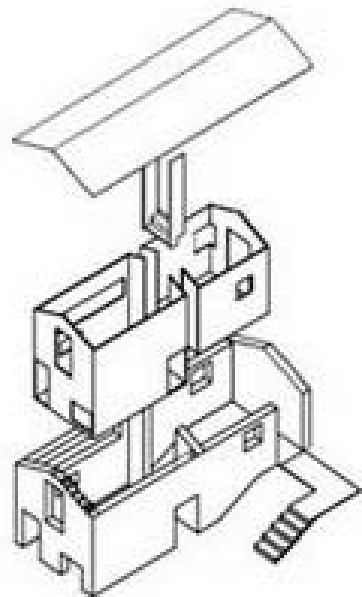

ARCHITECTURAL PRECEDENT | 037 |



ECONOMIC CENTER FOR ECOLOGICAL AGRO-TOURISM

The ECEAT was founded in Poland 1993 by Jadwiga Lopata to promote organic farming and agricultural tourism. During the economical transition in Poland, farmers

In Poland today, there are still 2 million farms, many of which who are struggling and in competition with corporate farms in Western Europe. This was founded to help small farms gain larger profits from their produce and work. The ECEAT to this day has worked with hundreds of farms and arranged vacations for tens of thousands of tourists, boosting its farmers income by twenty five percent.

Core values of the grassroots organization-

- provide relevant “eco” information to its guests
- support of environmental friendly agriculture
- use water and energy in an efficient and conscious/responsible way
- follow the green building policy
- reduce production of waste
- support soft mobility
- contribute to nature protection
- contribute to sustain cultural heritage
- contribute to support the local economy
- improve the environmental performance

ORGANIZATIONAL PRECEDENT | 039 |

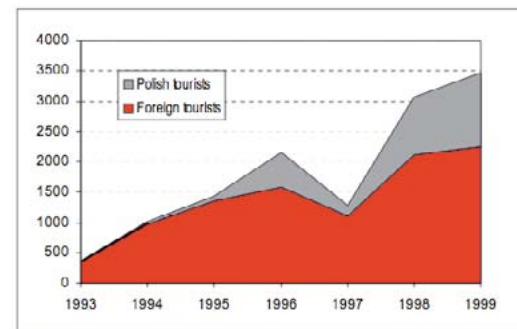

Source: ECEAT Poland

THE MUTUAL AID FOUNDATION BARKA

In the 1990's when the Polish government stopped subsidizing farms a grass roots community organization was started to help the homeless farmers. Tomasz Sadowski and his wife, both psychologists, purchased abandoned schoolhouse and moved in with their two daughters, and twenty homeless people. Together they renovated the schoolhouse and started a farm, which flourished into the foundation. The Barka system is informed by human imperfection- it provides assistant to alcoholics, addicts, and criminals who seek change. Today over 750 people live in Barka housing.

Another focus for the organization is helping to find employment for the formerly homeless people living in Barka communities. So far, work has been obtained in a variety of businesses, including recreation centers and construction sites, as well as temporary events such as the 2000 Poznan International Trade Fair. According to Ms. Sadowska, the Fair's organizers requested Barka workers again for this year's event because they are more trustworthy than other workers.



Abandoned dwellings and blocks of apartments acquired by Barka are typically in very poor condition, lacking floors, sewerage and electricity, uninsulated and with leaky roofs. These are renovated, including full insulation and brought back into a condition that is fit for human habitation. Local materials and labour are used wherever possible in order to provide low-cost and environmentally friendly accommodation.

Capacity building and training programmes are all part of Barka's mutual self-help programmes which helps to improve people's ability to participate in their community's life and decision-making processes. All Barka communities are based on partnership and responsibility, where residents share household duties and discuss all important problems and decisions. Even the older and frailer members of the community are encouraged to take an active role.

BARKAHOUSING.ORG



Historically, the people of Warmia and Masuria is full of tragedy and suffering. Injustice, hardship and pain often pressed on the shoulders of Warmians and Masurians... Dislike, injustice and violence surrounds us...They (Warmians and Masurians) demand respect for their differentness, grown in the course of seven centuries and for freedom to maintain their traditions”

The site selected is an abandoned farm located in an agricultural village, Pietrzyki in the northern Warmia- Masurian region of Poland. The region is located within the lands of one thousand lakes. The landscape is composed of landscape and national parks (45.1%), water (19.8%), and farming (25.5%).

Located from the site, ten kilometers west, is the city of Pisz. The city of Pisz is a centre for tourism. boat rides, canoeing and kayaking along the Pisa River and the Krutynia River. The European Union Foundation recently granted the Gmina Pisz region 150 Million zloty for the redevelopment of public space in the city and along the Pisa River front. Waszyngton Platz in the main historical square in Pisz,

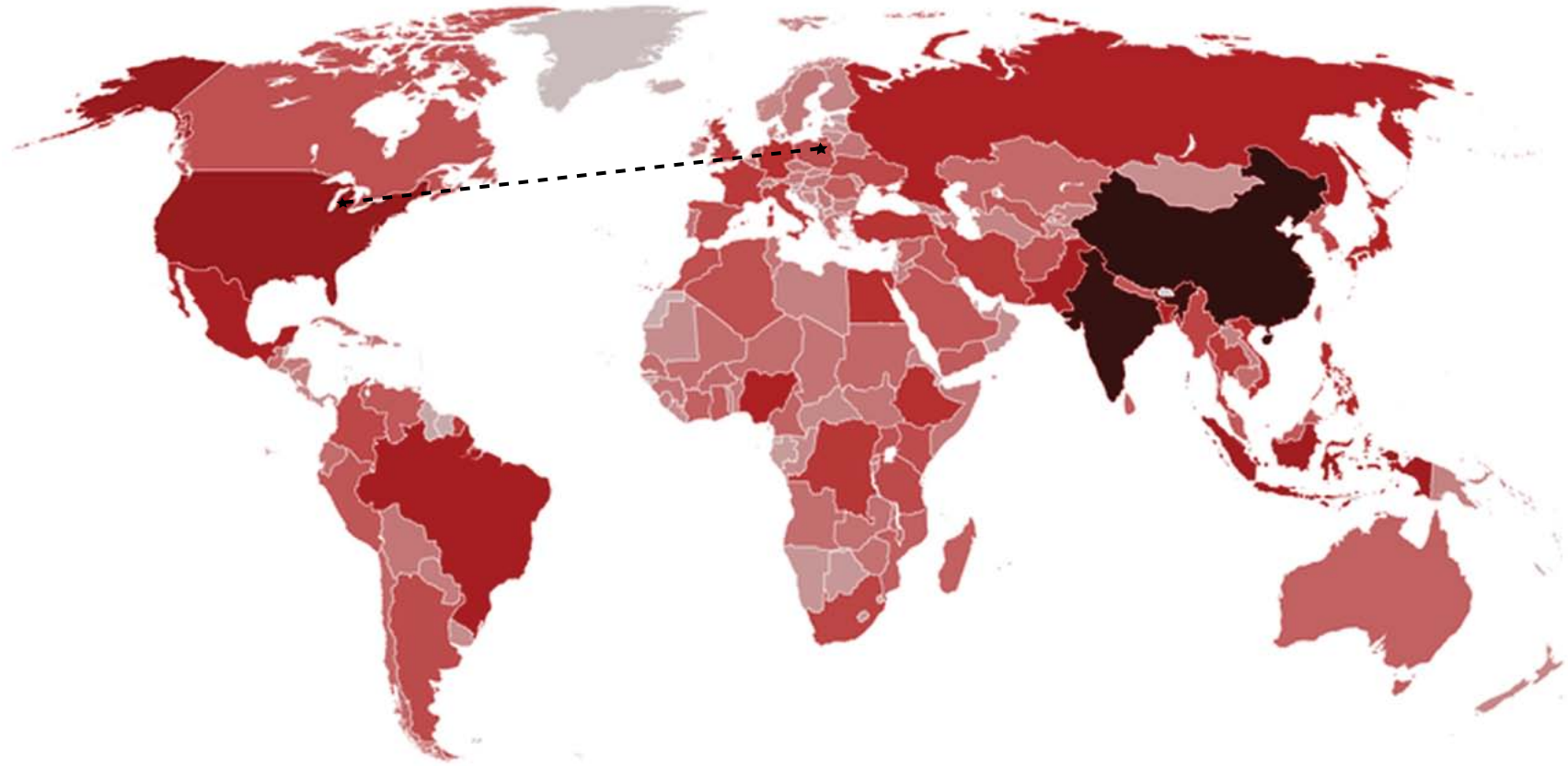



New re-development has consisted of Waszyngton Platz in the main historical square in Pisz, renovations to the river front and further development along the river to boost tourist economy, and a new sewer system that extends beyond the city limits. Within many of the villages in the village, village “swietlice” club-rooms, have been built for community gatherings and use. The club-rooms consist of large gathering rooms, small computer labs, and outdoor children play areas.

The forestry industry makes up 45.1% of the land. Located from the site, ten kilometers west, is the city of Pisz. The city of Pisz is a centre for tourism, boat rides, canoeing and kayaking along the Pisa River and the Krutynia River. With Poland joining the European Union, many projects in the region have been underway from European Union Foundation funding, a 150 Million Zloty grant to the Gmina Pisz region. New re-development has consisted of Waszyngton Platz in the main historical square in Pisz, renovations to the river front and further development along the river to boost tourist economy, and a new sewer system that extends beyond the city limits. Within many of the villages in the village, village “swietlice” club-rooms, have been built for community gatherings and use. The club-rooms consist of large gathering rooms, small computer labs, and outdoor children play areas.













The region is made up of 658 farms.
 The total population of the area is around 27,787, 13,920 women and 13,867 men.
 The density of the area, the town at approx. 1915 people/km² and the country 12 people/km².

The site is located in the center of local resources that are significant to the project.
 The farmer has the most valuable resource- land. The land production consists of potatoe, corn, and wheat production. The garden of the farm house consists of man fruits and vegetables.
 Animal production consists mainly of dairy farming. Livestock of the farm counsists of beef and swine.

The area consists of 4 primary schools in town and 12 in the country, 2 secondary schools 3 high schools (General Education School Complex, School Complex No 1, Vocational School Complex with the school workshops), State Primary Music School, and 3 kindergartens run by the commune. The city has a pulic library and a sports and recreation centre.

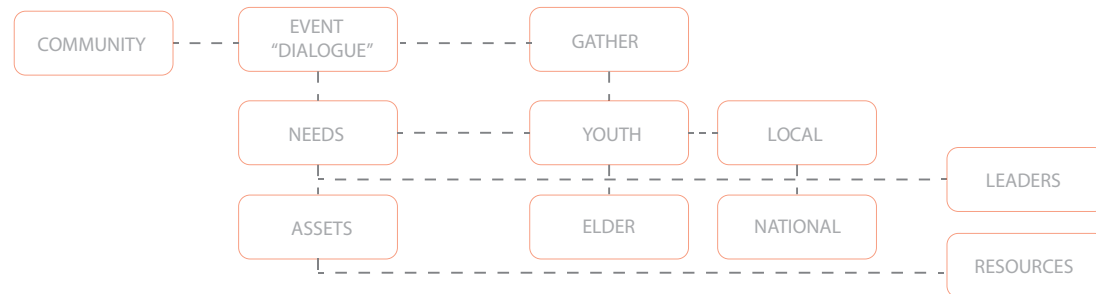
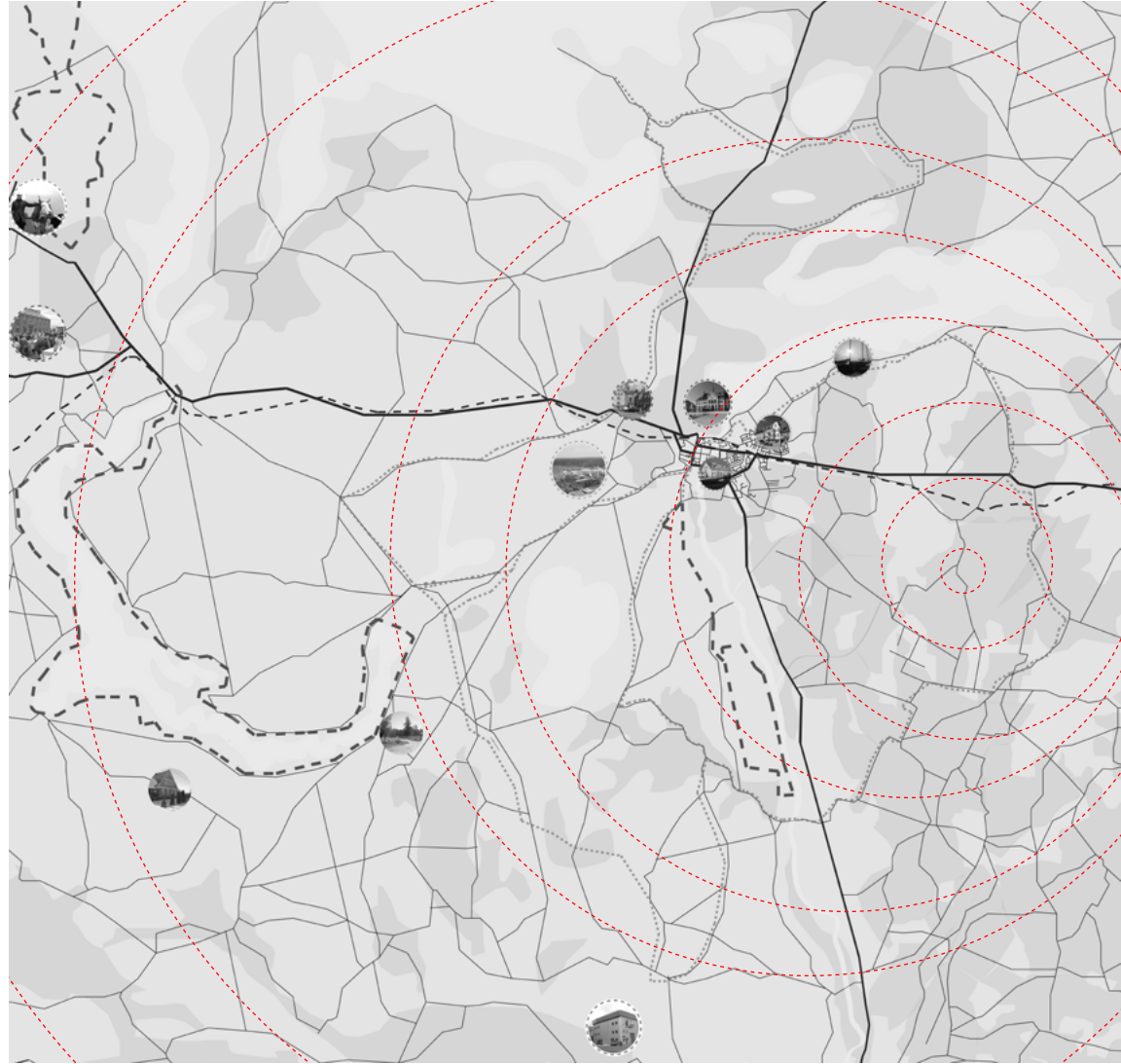

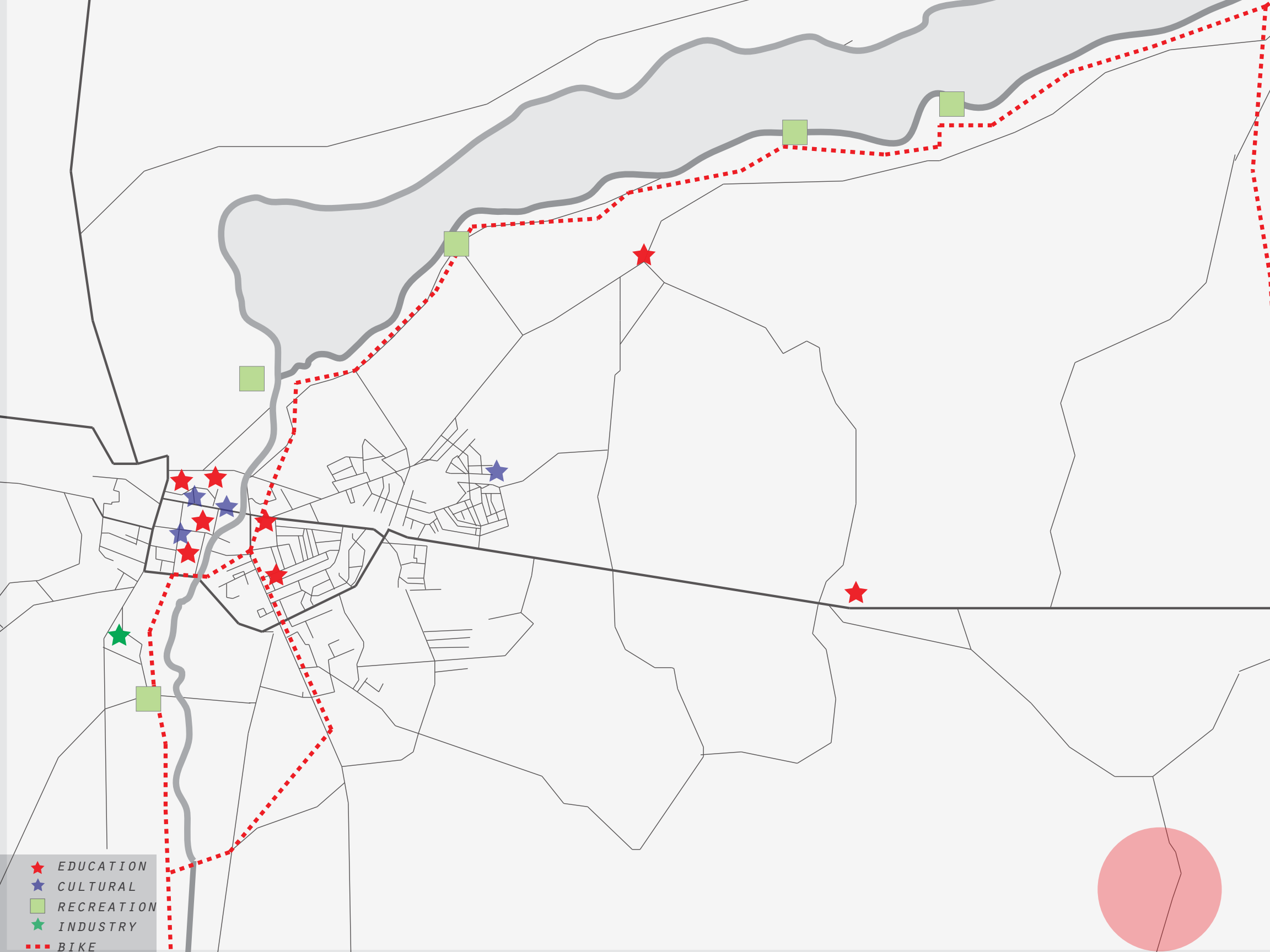

- ★ EDUCATION
- ★ CULTURAL
- RECREATION
- ★ INDUSTRY
- ⋯ BIKE

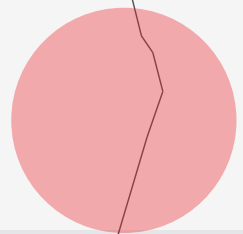

The beginning phase to the development would act as the economic generator to the village. The abandoned farm will be reprogrammed into a community based farm where farmers of the local region could use as a market place to sell their goods. The farm would provide a workshop space for creating spirits and delicatessens.

The phase would also redvelop a wing of the site into a studio space for local highschoolers. Using design as a tool of empowerment, the students will as active citizens creating for their fellow neighbor.

The second phase of the project would consist of allocating profits from the site to citizens of the region in need. In this phase a housing prototype would be developed.

The final phase of the project is the Agro+Design research center. The building would house a part for agricultural reasearch, while the second portion of the building would be a cultural center space.

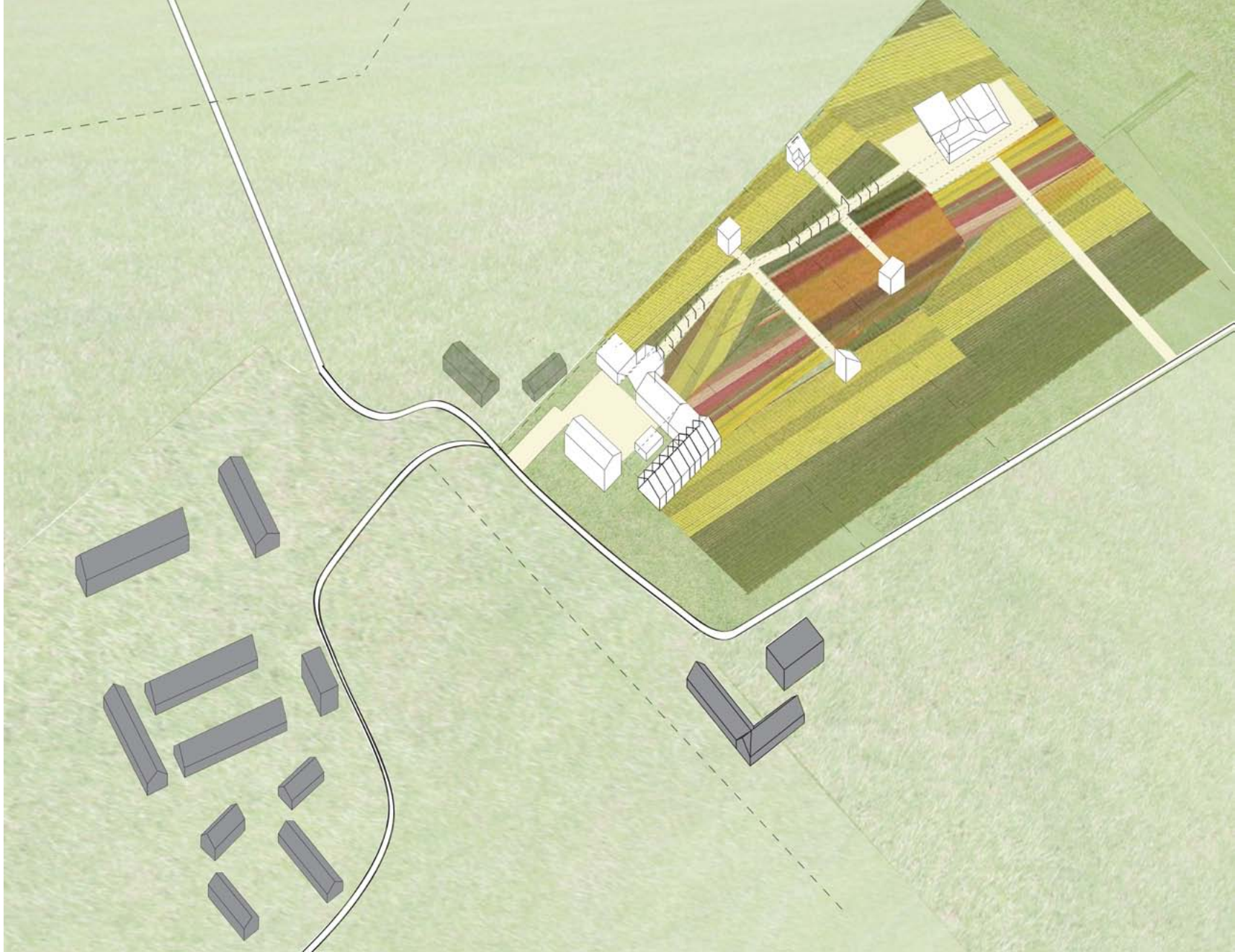
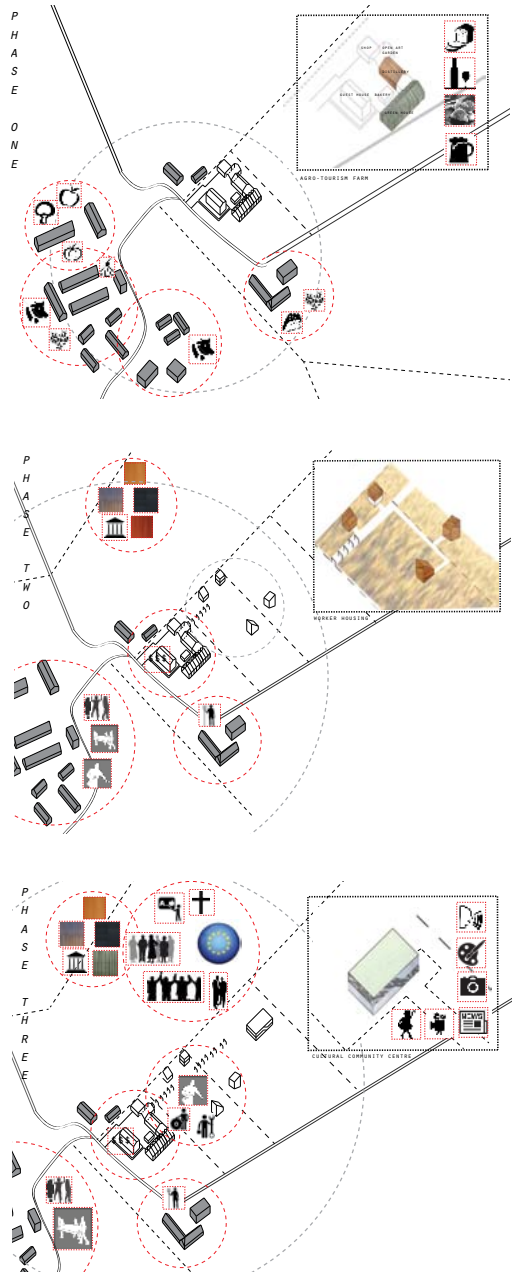

FINAL DESIGN | 069 |

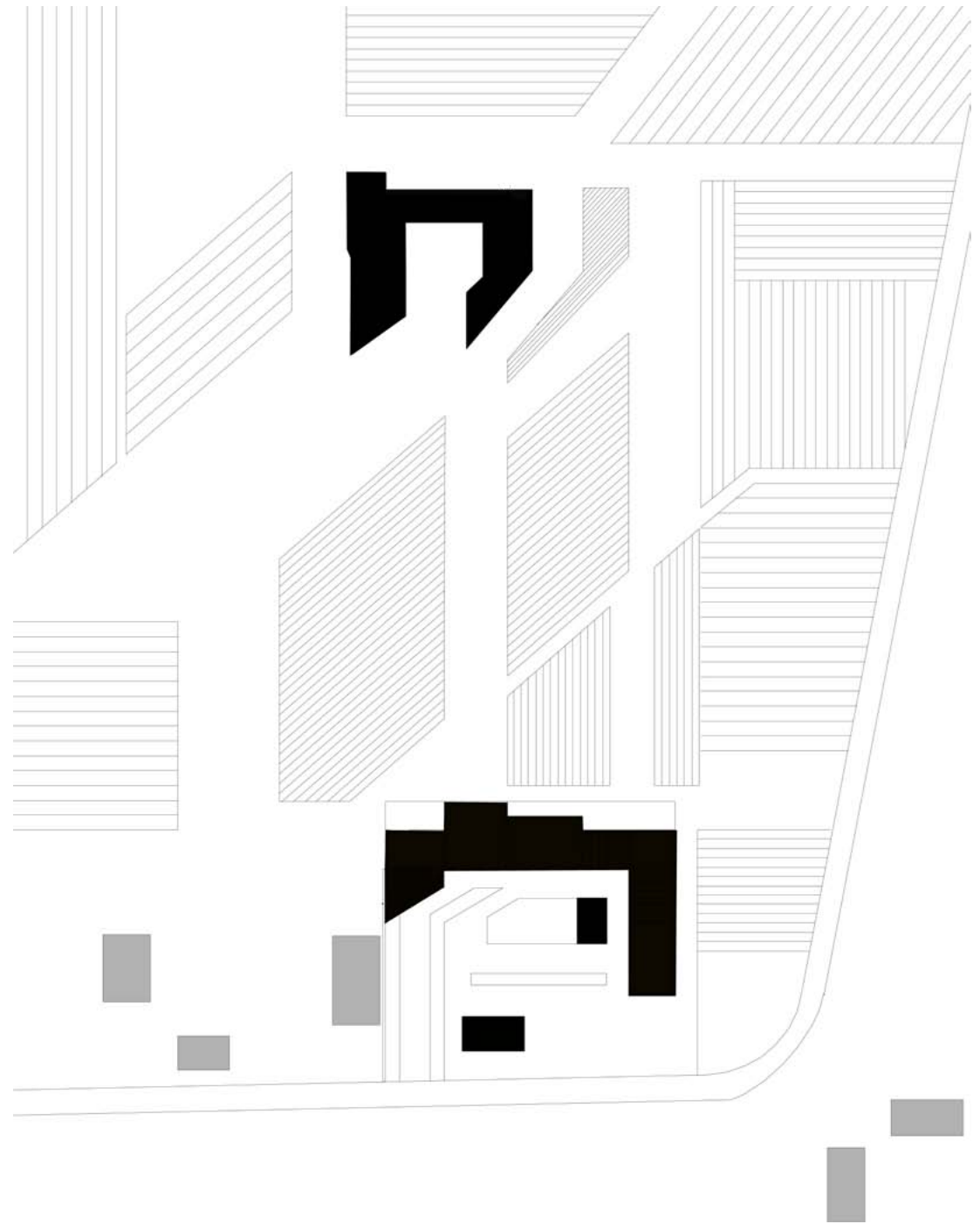

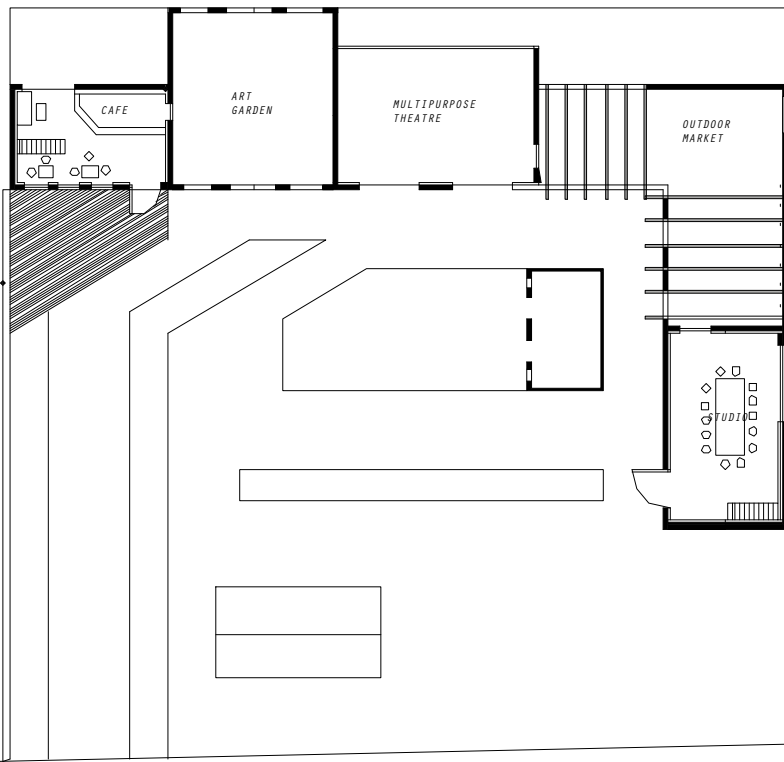

FINAL DESIGN | 072 |

FLOOR PLAN
AGRO+DESIGN CENTER (TRANSFORMED BARN)
LEVEL 1

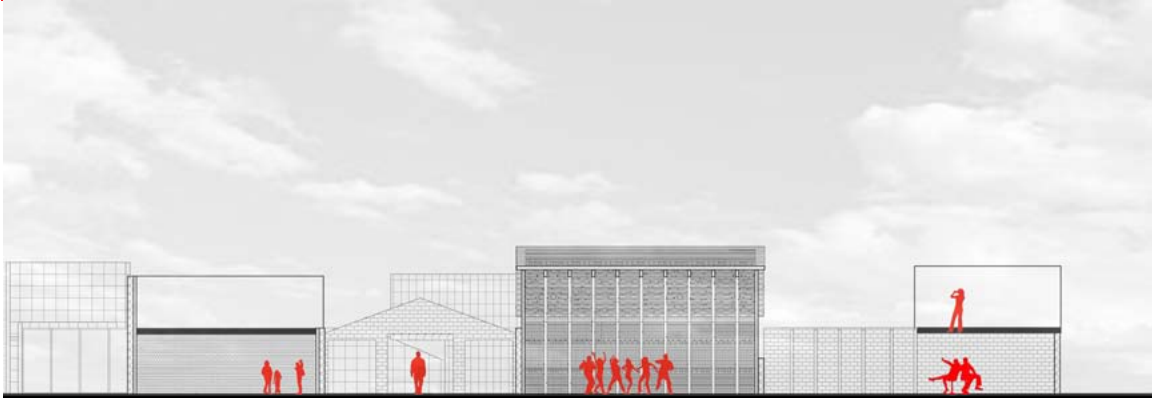

BARN SECTION



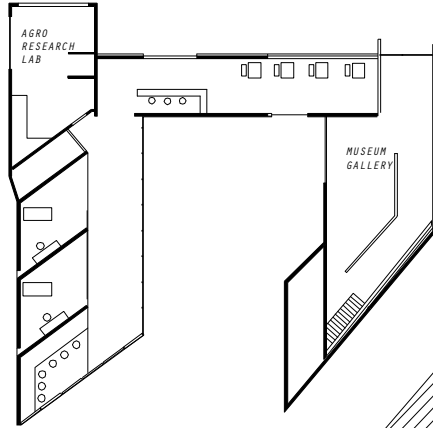

FINAL DESIGN | 076 |

FLOOR PLAN
AGRO+DESIGN CENTER
LEVEL 1+2

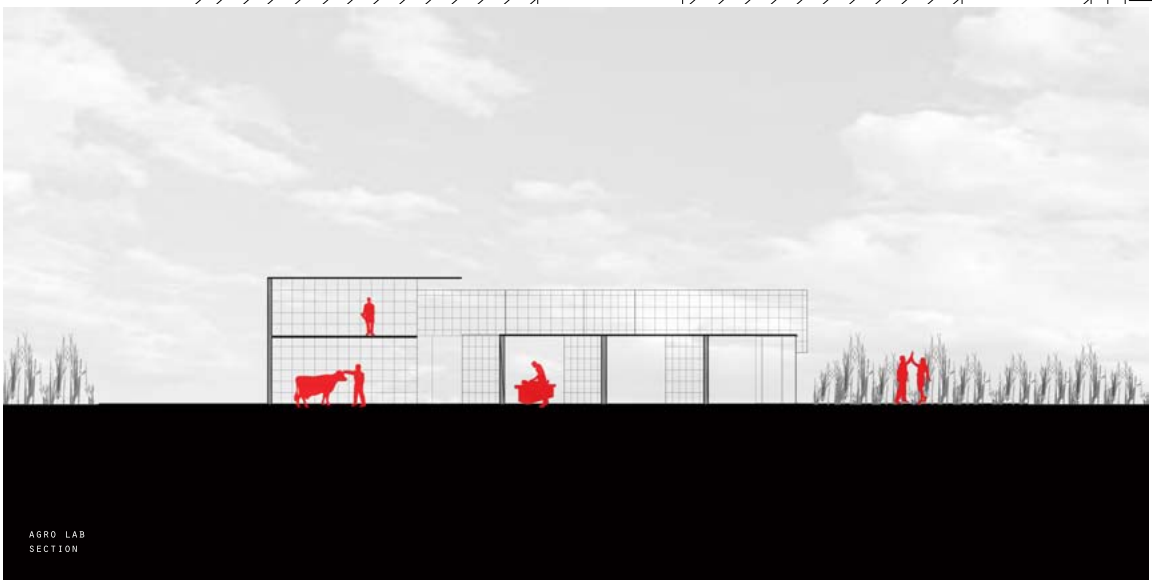

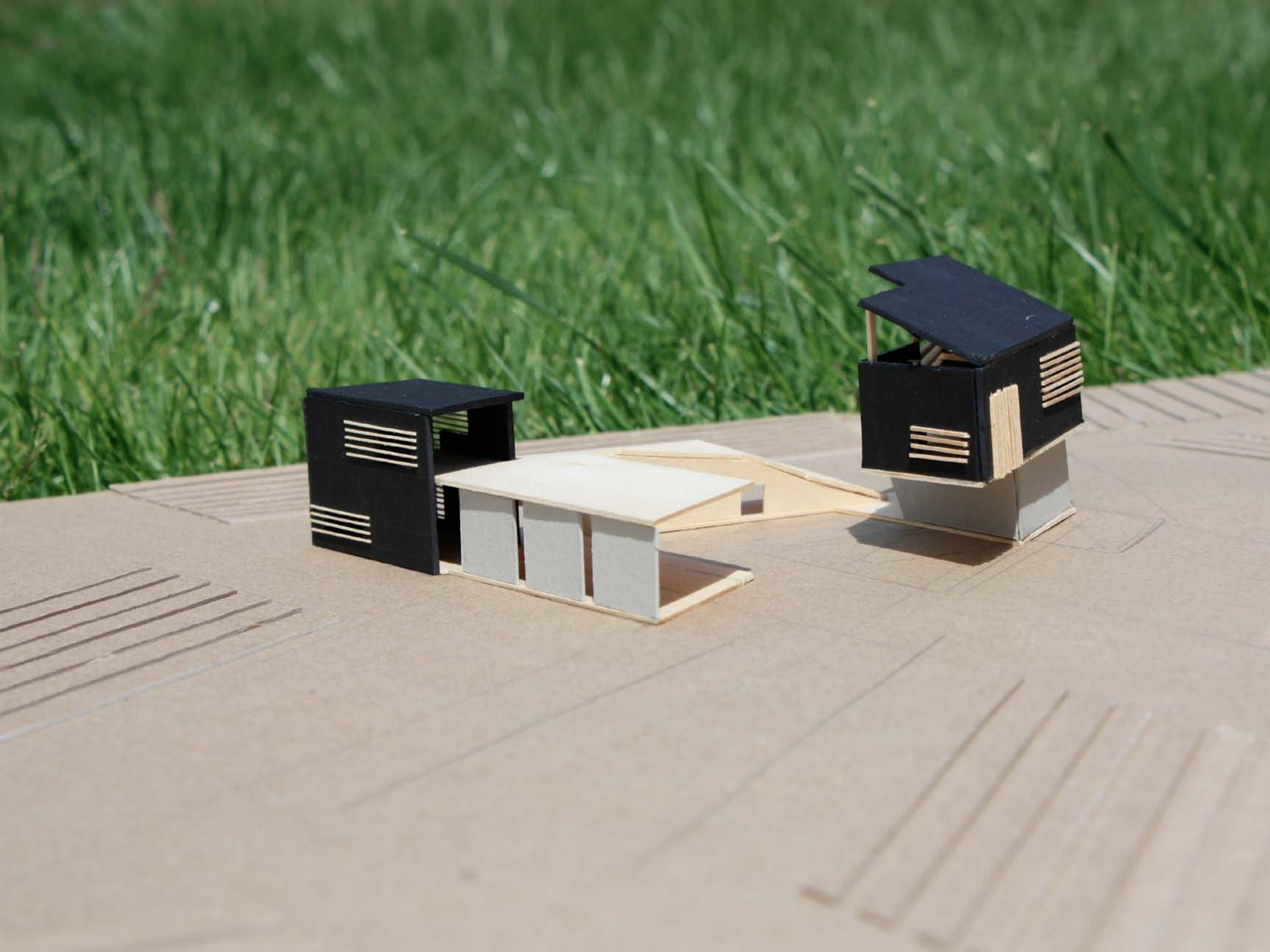

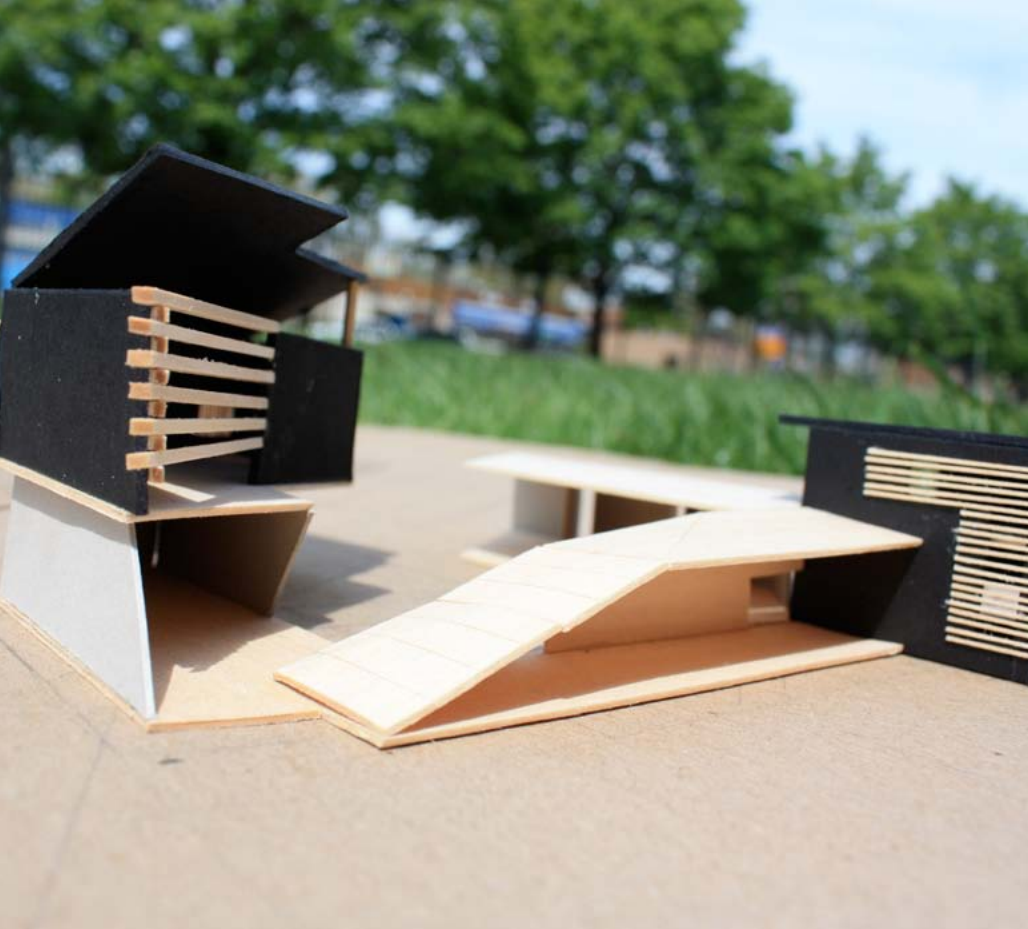

The thesis sought to explore the opportunities the rural landscape holds. The program of the thesis addresses the local needs of the community. The new program allows for design to influence a society that needs innovative thinking. Although an architecture has been created, further response to the historical site needs to be at play.

The new architecture must find unity with the farm. The new architecture must represent the social and political statement it is making. The site and the landscape must be further developed. The connection to the city is still in development.

Special Thanks:

I would like to give a special thanks to my advisor Karen Swanson, Mark Farlow, Noah Resnick, John Mueller for their guidance throughout the semester. Donzetta Jones, Alexis Saunders, and Elly Gravelle for being my mothers away from home.

To my family foremost, for always believing in me and supporting me through my studies.

A special thanks to all those who continue to believe in me along this journey.

Thank you.

